

N Channel Enhancement Mode Power MOSFET

GENERAL DESCRIPTION

The JY16M utilizes the latest trench processing techniques to achieve the high cell density and reduces the on-resistance with high repetitive avalanche rating. These features combine to make this design an extremely efficient and reliable device for use in power switching application and a wide variety of other applications.

FEATURES

- 600V/4A, $R_{DS(ON)}=2.6\Omega@V_{GS}=10V$
- Fast switching and reverse body recovery
- Excellent package for good heat dissipation

APPLICATIONS

- Lighting
- High efficiency switch mode power supplies

PIN DESCRIPTION

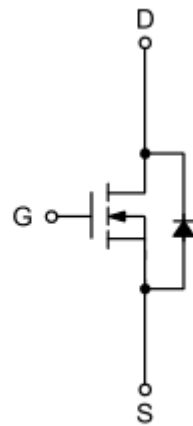
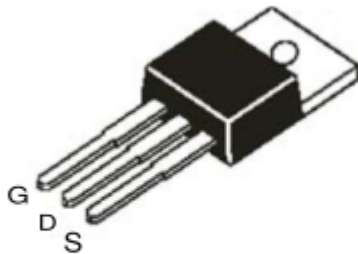

N-Channel MOSFET

JY16M

Absolute Maximum Ratings(Tc=25° C Unless Otherwise Noted)

Symbol	Parameter	Rating	Unit	
V _{DS}	Drain-Source Voltage	600	V	
V _{GS}	Gate-Source Voltage	± 30	V	
I _D	Continuous Drain Current	Tc=25° C	4	A
		Tc=100° C	2.9	
I _{DM}	Pulsed Drain Current	16	A	
P _D	Maximum Power Dissipation	33	W	
T _J T _{STG}	Operating Junction and Storage Temperature Range	-55 to +150	° C	
R _{θJC}	Thermal Resistance-Junction to Case	1.5	° C/W	
R _{θJA}	Thermal Resistance-Junction to Ambient	62		

Electrical Characteristics(Tc=25° C Unless Otherwise Noted)

Symbol	Parameter	Conditions	Min	Typ	Max	Unit
Static Characteristics						
BV _{DSS}	Drain-Source Breakdown Voltage	V _{GS} =0V, I _{DS} =250uA	600			V
I _{DSS}	Zero Gate Voltage Drain Current	V _{DS} =600V, V _{GS} =0V			1	uA
I _{GSS}	Gate-Body Leakage Current	V _{GS} = ± 30V, V _{DS} =0V			± 100	nA
V _{GS(th)}	Gate Threshold Voltage	V _{DS} = V _{GS} , I _{DS} =250uA	2.0	3.0	4.0	V
R _{DS(ON)}	Drain-Source On-state Resistance	V _{GS} =10V, I _{DS} =4A		2.6	2.8	Ω

Electrical Characteristics(Tc=25°C Unless Otherwise Noted)

Symbol	Parameter	Conditions	Min	Typ	Max	Unit
Drain-Source Diode Characteristics						
V_{SD}	Diode Forward Voltage	$V_{GS}=0V, I_{SD}=2A$			1.5	V
T_{rr}	Reverse Recovery Time	$I_{SD}=4A$		260		ns
Q_{rr}	Reverse Recovery Charge	$di/dt=100A/us$		1.5		nC
Dynamic Characteristics						
R_G	Gate Resistance	$V_{GS}=0V, V_{DS}=0V,$ $f=1MHz$		5		Ω
$T_{d(on)}$	Turn-on Delay Time	$V_{DS}=300V,$ $R_G=25\Omega,$ $I_{DS}=4A, V_{GS}=10V,$		15		ns
T_r	Turn-on Rise Time			48		
$T_{d(off)}$	Turn-off Delay Time			28		
T_f	Turn-off Fall Time			35		
C_{ISS}	Input Capacitance	$V_{GS}=0V,$ $V_{DS}=25V,$ $f=1.0MHz$		528		pF
C_{OSS}	Output Capacitance			72		
C_{RSS}	Reverse Transfer Capacitance			9		
Q_g	Total Gate Charge	$V_{DS}=480V, I_D=4A,$ $V_{GS}=10V$		16		nC
Q_{gs}	Gate-Source Charge			3.5		
Q_{gd}	Gate-Drain Charge			7.1		

Typical electrical and thermal characteristics

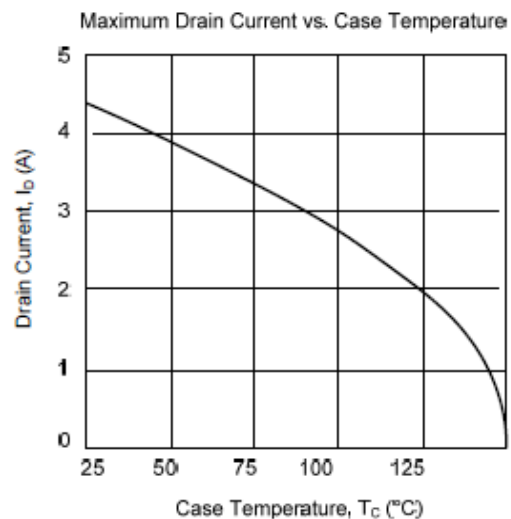
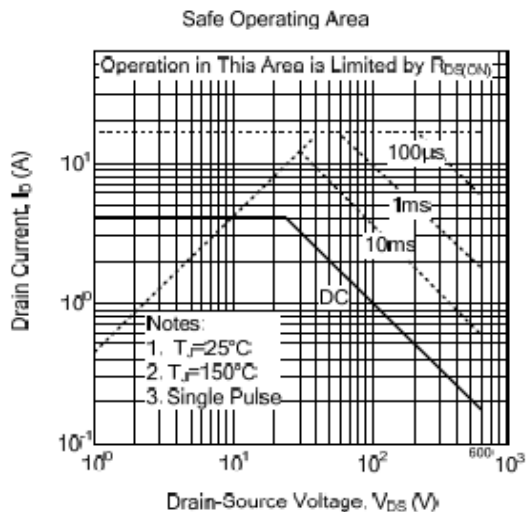
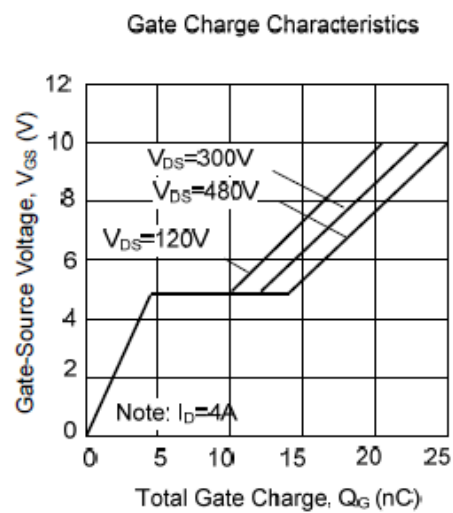
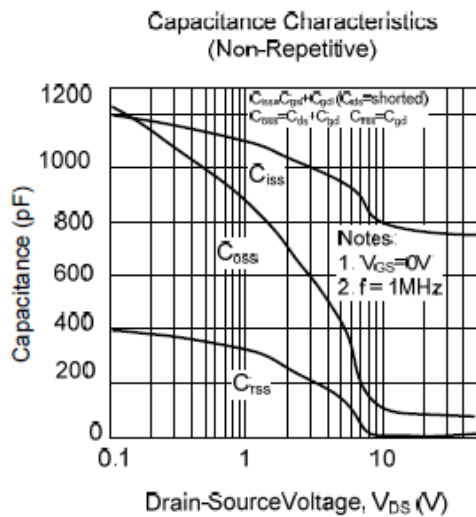
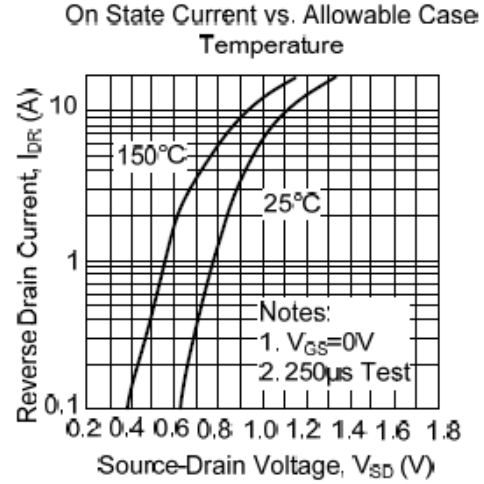
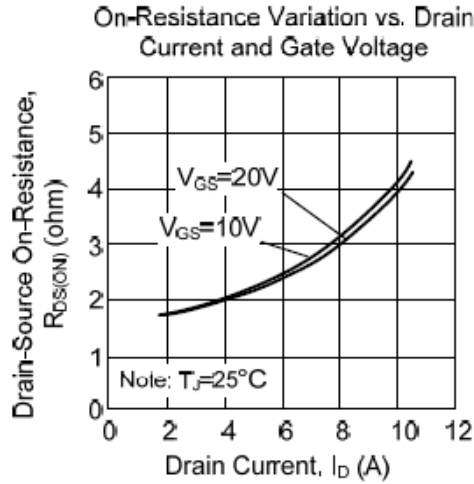

Typical electrical and thermal characteristics

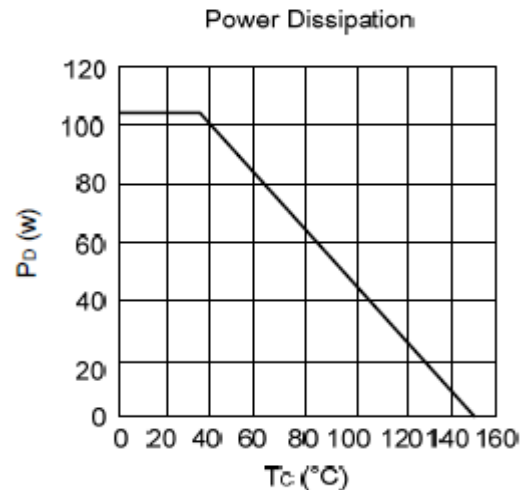
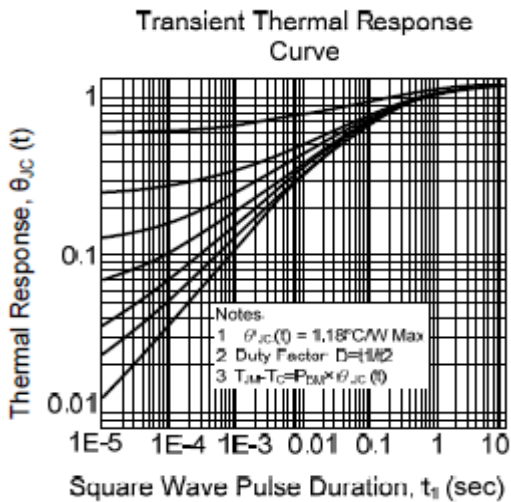
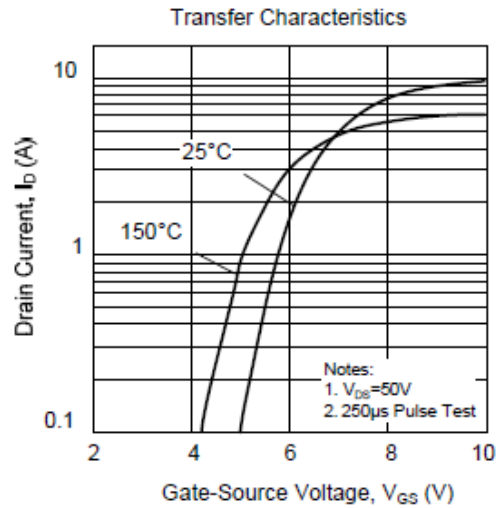
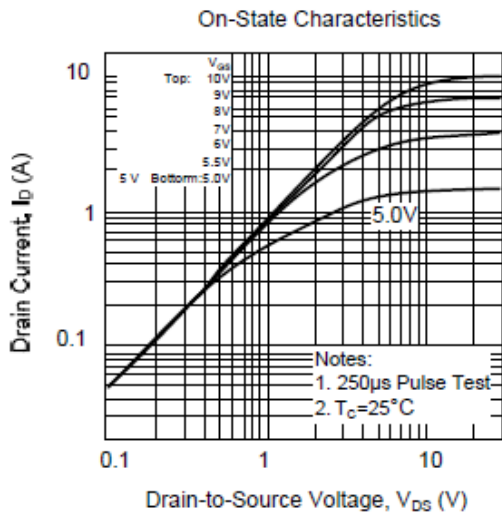
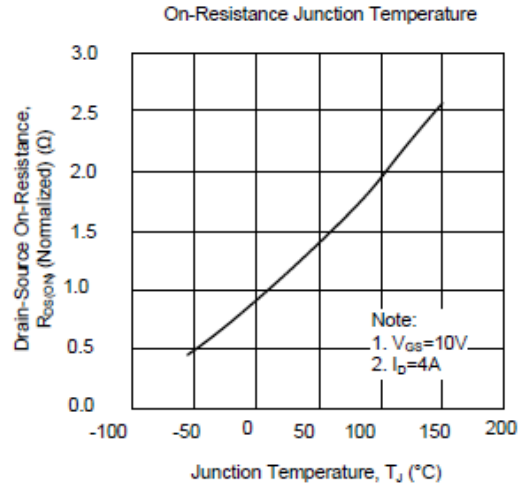
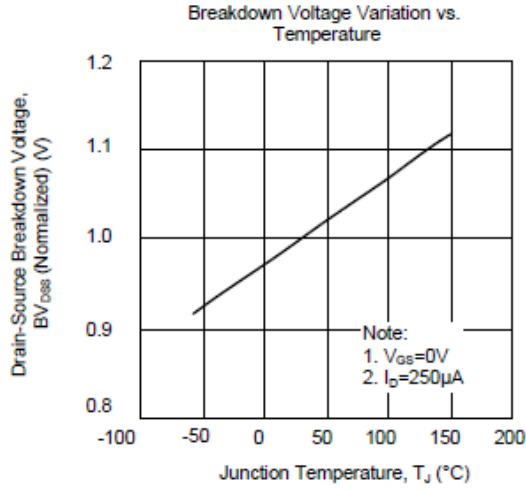

TO220F-3 Package Outline

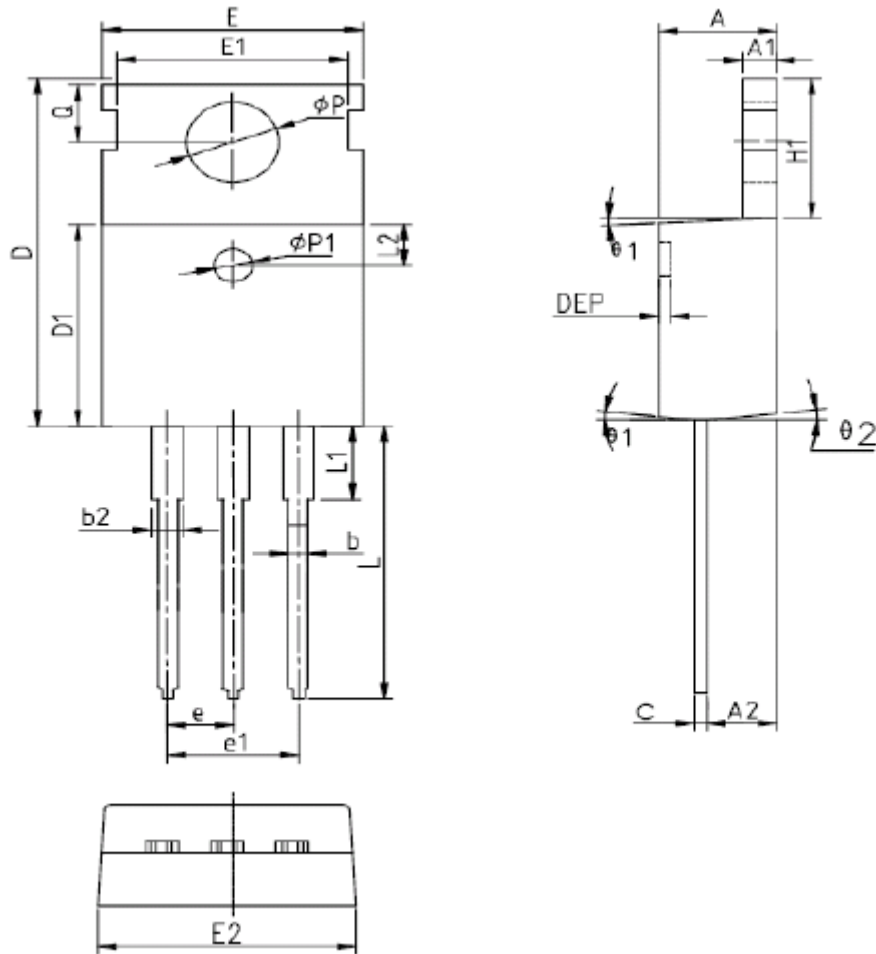

SYMBOL	MM			INCH			SYMBOL	MM			INCH		
	MIN	NOM	MAX	MIN	NOM	MAX		MIN	NOM	MAX	MIN	NOM	MAX
A	4.40	4.57	4.70	0.173	0.180	0.185	$\phi p1$	1.40	1.50	1.60	0.055	0.059	0.063
A1	1.27	1.30	1.33	0.050	0.051	0.052	e	2.54BSC			0.1BSC		
A2	2.35	2.40	2.50	0.093	0.094	0.098	e1	5.08BSC			0.2BSC		
b	0.77	-	0.90	0.030	-	0.035	H1	6.40	6.50	6.60	0.252	0.256	0.260
b2	1.23	-	1.36	0.048	-	0.054	L	12.75	-	13.17	0.502	-	0.519
C	0.48	0.50	0.52	0.019	0.020	0.021	L1	-	-	3.95	-	-	0.156
D	15.40	15.60	15.80	0.606	0.614	0.622	L2	2.50REF.			0.098REF.		
D1	9.00	9.10	9.20	0.354	0.358	0.362	ϕp	3.57	3.60	3.63	0.141	0.142	0.143
DEP	0.05	0.10	0.20	0.002	0.004	0.008	Q	2.73	2.80	2.87	0.107	0.110	0.113
E	9.70	9.90	10.10	0.382	0.389	0.398	$\theta 1$	5°	7°	9°	5°	7°	9°
E1	-	8.70	-	-	0.343	-	$\theta 2$	1°	3°	5°	1°	3°	5°
E2	9.80	10.00	10.20	0.386	0.394	0.401							